

CASE 5.0

BECOMING

CASE 5.0

BECOMING

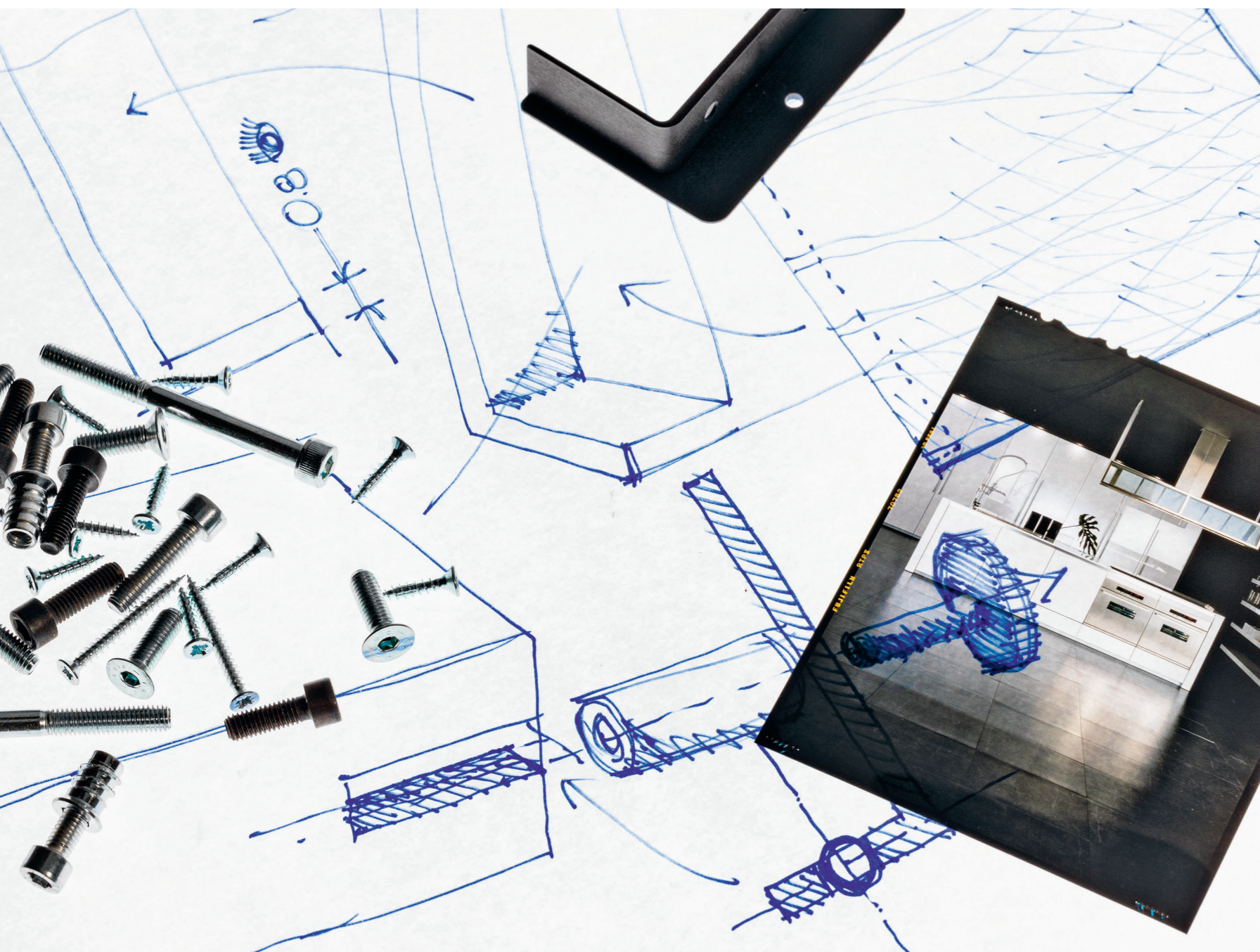

WITH EVEN THE MOST REVOLUTIONARY NEW DESIGN, EVERY KITCHEN EMBODIES ANCIENT CONCEPTS, A MEETING PLACE FOR THE FOUR PRIMARY ELEMENTS — AIR, EARTH, FIRE, WATER — AND A FIFTH, QUINTESSENTIAL ELEMENT: DESIGN.

AT THE HEART OF BOFFI'S APPROACH TO DESIGN AND MANUFACTURING IS A WORD THAT, APPROPRIATELY, CONTAINS MORE THAN ONE MEANING. IN ENGLISH, BECOMING CAN BE A PHILOSOPHICAL CONCEPT, OWING A DEBT TO HERACLITUS — WHO NEVER STEPPED IN THE SAME RIVER TWICE — AND DENOTING THE “STATE OF BECOMING,” A PROGRESSIVE, TRIAL AND ERROR PROCESS OF CHANGE, FAILURE, AND SUCCESS. SAMUEL BECKETT'S MANTRA WAS “TRY AGAIN, FAIL AGAIN, FAIL BETTER.” IN EACH ITERATION OF BECOMING, BOFFI AND LISSONI HAVE WORKED TOGETHER TO REFINE AND PERFECT. SECONDARILY, BECOMING ALSO MEANS SOMETHING ATTRACTIVE, FLATTERING, AND IDEALLY SUITED TO THE PERSON WHO OWNS OR USES IT. THAT PROCESS OF “BECOMING” LED TO CASE 5.0 — EMINENTLY USABLE AND PERFECTLY MATCHED WITH THE DESIRES OF THOSE WHO COOK AND SOCIALIZE IN AND WITH IT.

CREATORS OF KITCHENS HAVE ALWAYS WORKED TO BALANCE THE DELIGHT AND ADVENTURE OF COOKING WITH THE CONVENIENCE AND EFFICIENCY OFFERED BY TECHNOLOGY. BUT THE FORMULA STILL ENCOMPASSES CRUCIAL MATERIALS AND FUNDAMENTAL TECHNIQUES. A THEORY OF ELEMENTS NEARLY AS OLD AS THE VERY FIRST OUTDOOR KITCHEN DESCRIBES JUST FOUR ESSENTIAL COMPONENTS: AIR, EARTH, FIRE, AND WATER. THESE FOUR ELEMENTS ARE THE SOUL OF ANY KITCHEN, AND THEY MERGE AND SHAPE BOTH THE ACT OF COOKING AND THE PROCESS OF DESIGN.

SOME MIGHT ADD A QUINTESSENCE, A FIFTH ELEMENT: THOUGHTFUL, PERCEPTIVE DESIGN. BOFFI UNITES ALL FIVE OF THOSE ELEMENTS IN CASE 5.0.

THE 5.0 CM THICKNESS OF THE CASE 5.0 CABINET DOORS — ENCLOSING THE NATURAL WALNUT WOOD DRAWERS — INCORPORATES AN 8 MM SECTION THAT FRAMES IT, BECOMING ITS HANDLE. THE THICKNESS AND MASS OF THE DOORS ENDOW IT WITH A SPECIAL TACTILE SENSE OF SOLIDITY. THE HANDLE STRIPS WITH THE SAME FINISH AS THE BASE CABINETS REINFORCE THE UNITS' CONTINUITY. THE CABINETS FEATURE PULL-OUT DOORS, NOT HINGED, AND 9 CM SIDE SUPPORT PANELS. THE COUNTERTOP IS RELATIVELY THIN — 1.2 TO 2 CM — ESTABLISHING A CONTRAST WITH THE MUCH THICKER CABINET DOORS. THIS YEAR, NEW FEATURES ARE BEING INTRODUCED: CANTILEVERED KITCHEN PENINSULAS EXTENDING UP TO 180 CM AND NEW MATERIALS FOR DOORS AND COUNTERTOPS SUCH AS MDI BY INALCO WITH NEW AND EXCLUSIVE COLORS, LOST WOODS, AND SUCH ABSOLUTE NOVELTIES — SELECTED BY PIERO LISSONI — AS EASY METALS AND GLOSSY POLYESTERS. LAST BUT CERTAINLY NOT LEAST: INSIDE SYSTEM TRACKS, EQUIPPED TRACKS INTEGRATED INTO THE COUNTERTOPS OFFERING CUTLERY AND UTENSIL TRAYS AND HOLDERS FOR KNIVES, SPICES, CUTTING BOARDS, AND OIL BOTTLES.

WHEN PIERO LISSONI DESIGNED CASE 5.0 IN 2002, HE MADE A POINT OF PRESENTING IT TO THE PUBLIC AT THE CAPRONI INDUSTRIAL SHED OUTSIDE MILAN. HERE A LONG-FORGOTTEN MASTER DESIGNER AND AVIATION PIONEER NAMED GIANNI CAPRONI HAD PRODUCED GENERATIONS OF AIRPLANES — CLASSICS IN TERMS OF PERFORMANCE AND DESIGN. THIS WAS AN UNUSUAL WAY TO ANNOUNCE A NEW APPROACH TO KITCHENS, BUT IT WAS AHEAD OF ITS TIME, LIKE EVERYTHING THAT BEARS THE BOFFI AND LISSONI NAMES.

KITCHENS AND AIRPLANES BOTH EMBODY HUMANITY'S OLDEST AND MOST CHERISHED DREAMS AND ASPIRATIONS. CASE BRINGS ADVANCED DESIGN AND IMPECCABLE TASTE TO THE CHALLENGE AND DELIGHT OF COOKING. THE SURFACES AND SPACES ARE CALIBRATED TO MAKE THE EXPERIENCE OF COOKING AS NATURAL AND YET EFFICIENT AS A DREAM, A PLACE WHERE FOOD CONJURES UP BOTH THE COMFORT OF PRIVACY — WHEN EATING IN CLOSE COMPANY — AND THE JOYS OF CONVIVIALITY — WHEN ENTERTAINING FRIENDS AND COLLEAGUES.

THE TWENTY YEARS BETWEEN THE ORIGINAL INTRODUCTION OF CASE 5.0 AND THE NEW ITERATION OF CASE 5.0 HAVE BEEN A TIME OF TECHNOLOGICAL AND DESIGN ADVANCES, BUT ALSO A TIME IN WHICH BOFFI AND LISSONI HAVE STUDIED AND LISTENED TO THE CONSUMER.

WHEN DESIGN PROCESS CREATES A KITCHEN, WE CAN LOOK AT THAT BECOMING IN SURFACE TERMS. THE DESIGN AND ENGINEERING SHAPES A “PERSONA,” A WORD THAT COMES FROM THE ANCIENT ACTOR'S MASK. THE COUNTERS, THE CABINETS, AND THE OTHER CRUCIAL NODES — STOVE, REFRIGERATOR, SINK, AND SO ON — ARE STAGE SETTINGS FOR A DOMESTIC THEATER OF COOKING, BUT ALSO AN INTERFACE LINKING THE DEEPER KNOWLEDGE AND TRADITIONS OF CUISINE WITH THE DAILY LIFE THAT FLOWS THROUGH ANY AND EVERY KITCHEN — A “DESIRE LINE” THAT SHAPES THE DESIGN AND PRACTICE OF COOKING AND ENTERTAINING.

DESIGN, LIKE COOKING, IS A PROCESS OF BECOMING.

PICTURE THIS: A STACKED LAYERING OF MEDIA, A ROUGH, HAND-SKETCHED CONCEPTUAL, THEN LAYERED, TRANSLUCENT ABOVE IT, A FORMAL, FINE-LINED RENDERING, ON TOP OF THAT, GHOSTLY BUT CLEAR, A SCHEMATIC WITH MANUFACTURING INSTRUCTIONS, FLOATING EVANESCENT TO ONE SIDE, A SAMPLE BOARD OF MATERIALS, WOOD, METAL, COMPOSITES, AND THEN, AT THE APEX OF THE VISUALIZED CONSTRUCTION PROCESS, A PHOTOGRAPH OF THE FINISHED KITCHEN CABINETRY, CASE 5.0.

GOOD KITCHEN DESIGN DOMESTICATES THE ANCIENT RITUAL AND ALCHEMY OF COOKING, THE MYSTERIOUS PROCESS THAT SHAPES THE MAGNETIC CENTER OF OUR HOMES. IN ITALIAN, THE SAME WORD, “CUCINA,” DESCRIBES BOTH THE PROCESS OF COOKING — CUISINE — AND THE PLACE WHERE IT IS DONE — KITCHEN. THE MATERIAL ELEMENTS OF EARTH, PRESENT IN STONE, CERAMICS, METAL, COMBINE WITH FIRE, WATER, AND AIR AND DESIGN, THE QUINTESSENTIAL FIFTH ELEMENT, THE SPARK THAT LIGHTS THE FLAME: FINE AND THOUGHTFUL DESIGN.





FLANKED BY CANTILEVERED SNACK COUNTERS MADE OF ALPI DATUK EBONY, AN ECOWOOD THAT BELONGS TO THE SO-CALLED LOST WOODS FAMILY — SUPPORTED BY ASYMMETRICAL L-FOOTPRINT BLACK ANODIZED ALUMINUM LEGS WHERE POSSIBLE — THE ISLAND FEATURES AN INDUCTION COOKTOP IN MDI KANRAN BY INALCO, WHILE THE BASES ARE IN DEEP GRAY POLYESTER. AS WITH ALL THE CABINET DOORS IN THE CASE LINE, THE 5 CM THICKNESS — HENCE THE 5.0 SUFFIX IN THE NAME — MAKES IT POSSIBLE TO INSET AN INVISIBLE RECESSED CHANNEL HANDLE. THE GLASS AND MIRRORED COUNTERTOP CABINETS ATOP THE ISLAND'S COUNTER SURFACE COMPLEMENT THE OVERALL APPEARANCE. THE TILE RANGE HOOD IN CROSS ECOWOOD XILO 2.0 STRIPED BLACK TRACEWOOD FINISH PROVIDES A SUBTLE CONTRAST IN MATERIAL AND TEXTURE TO THE OVERALL COMPOSITION. THE FLOOR-TO-CEILING WALL CABINETS FEATURE BASES IN AMERICAN ELM AND WALL UNITS IN HAMMERED DEODD STAINLESS STEEL BY DE CASTELLI, OFFERING A SHARP ALTERNATIVE TO THE BLACK COUNTERTOP.

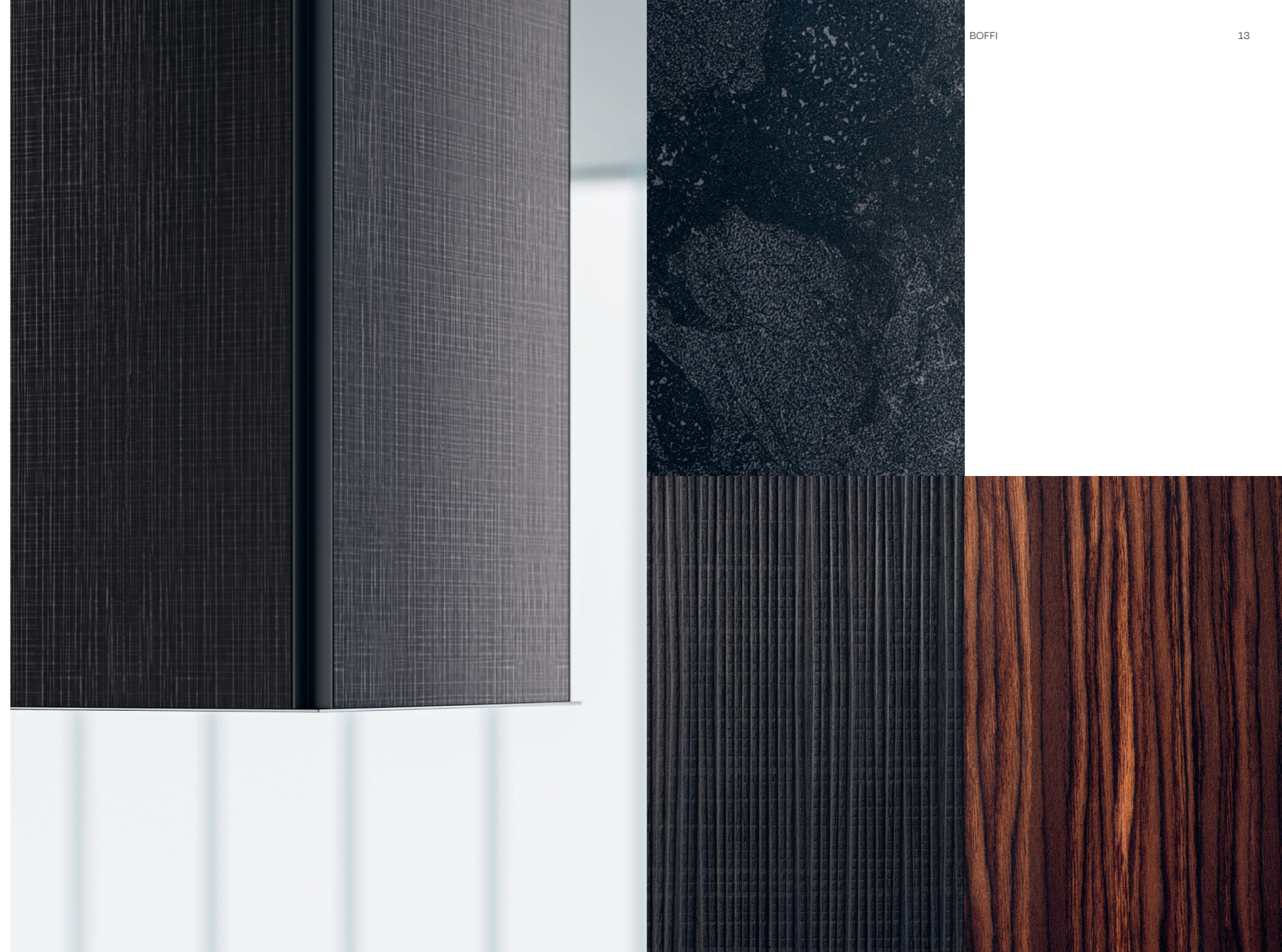

#1 2014
KITCHENOLOGY

Boffi



MODEL C

CASE 5.0

BECOMING

BOFFI

15



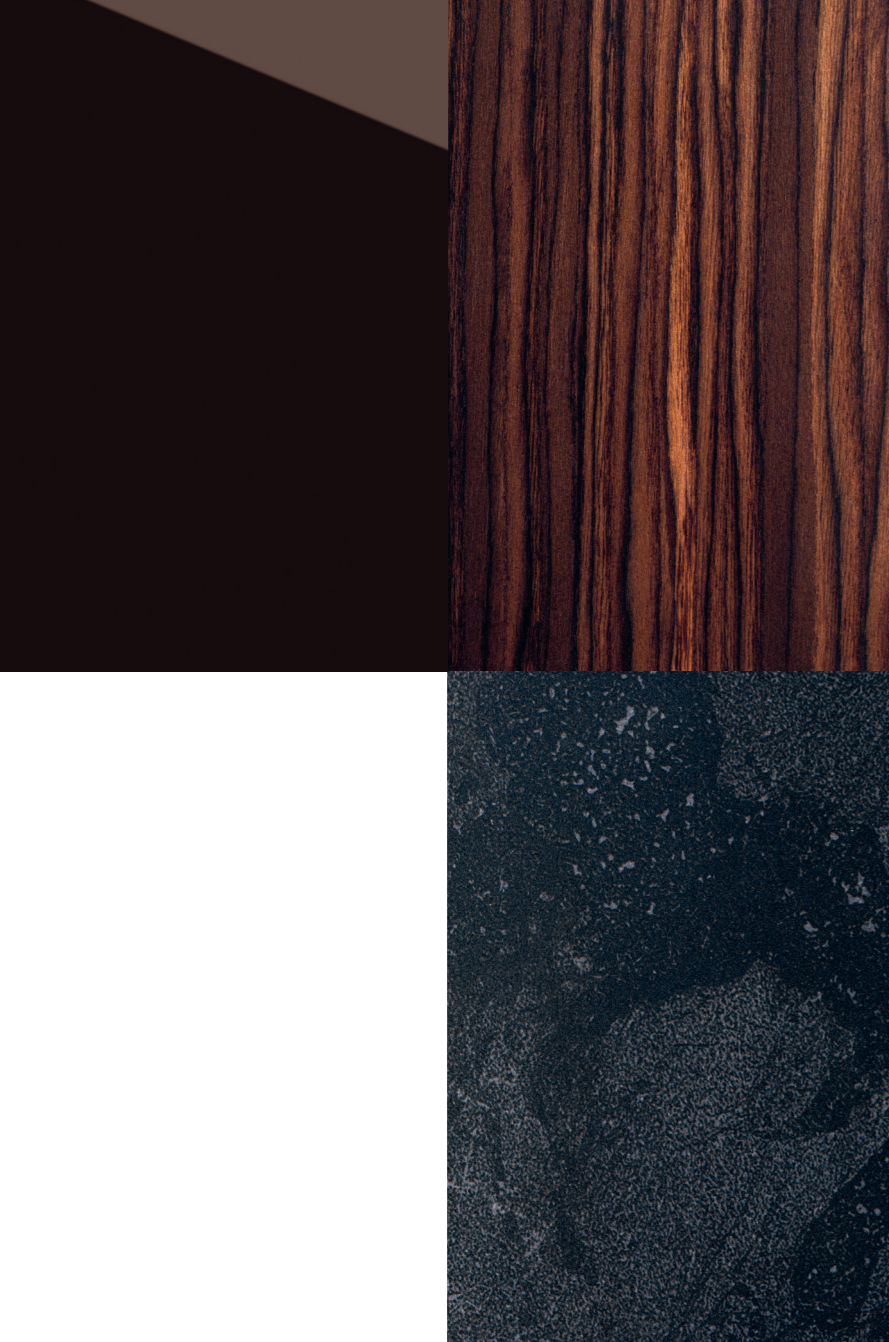

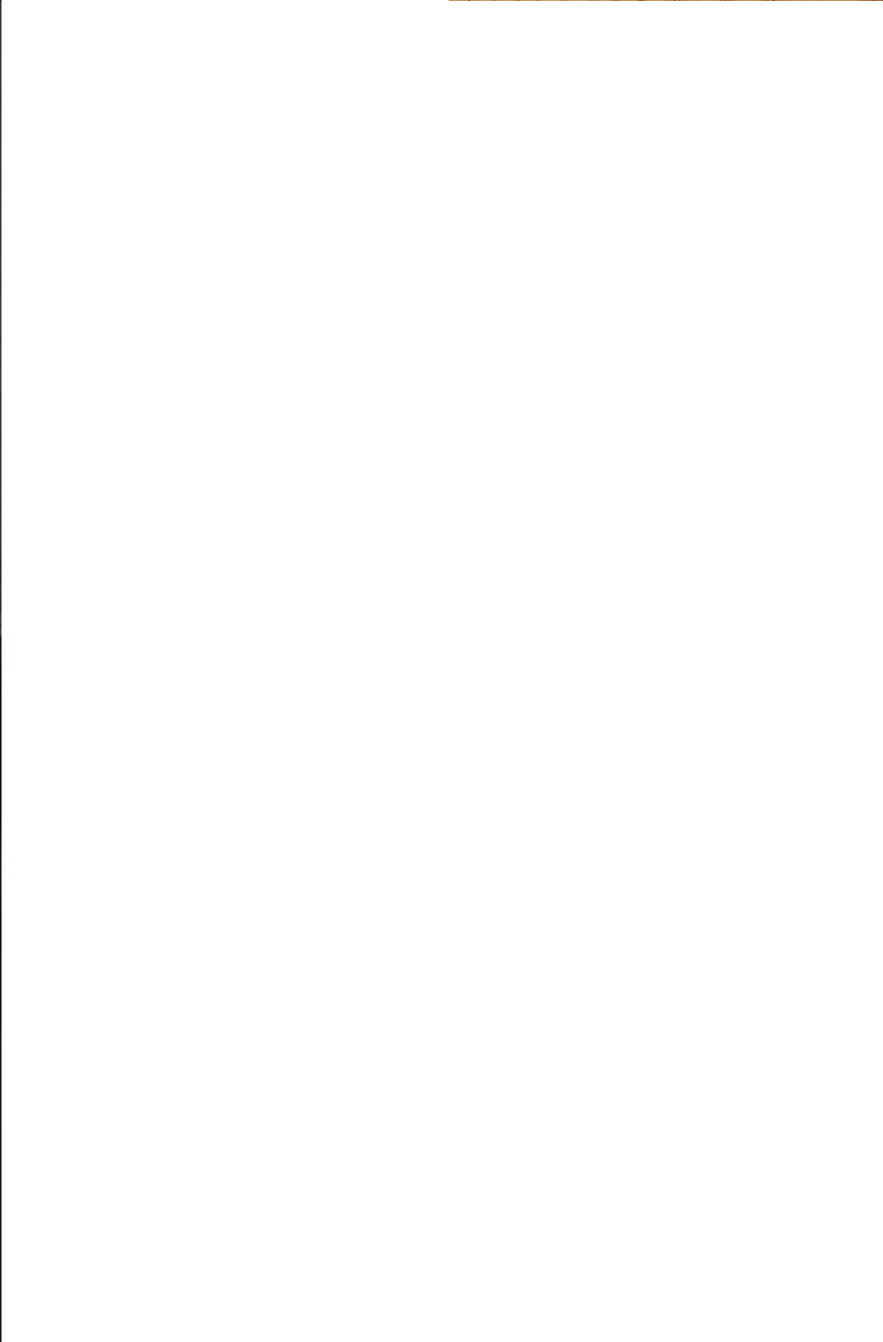
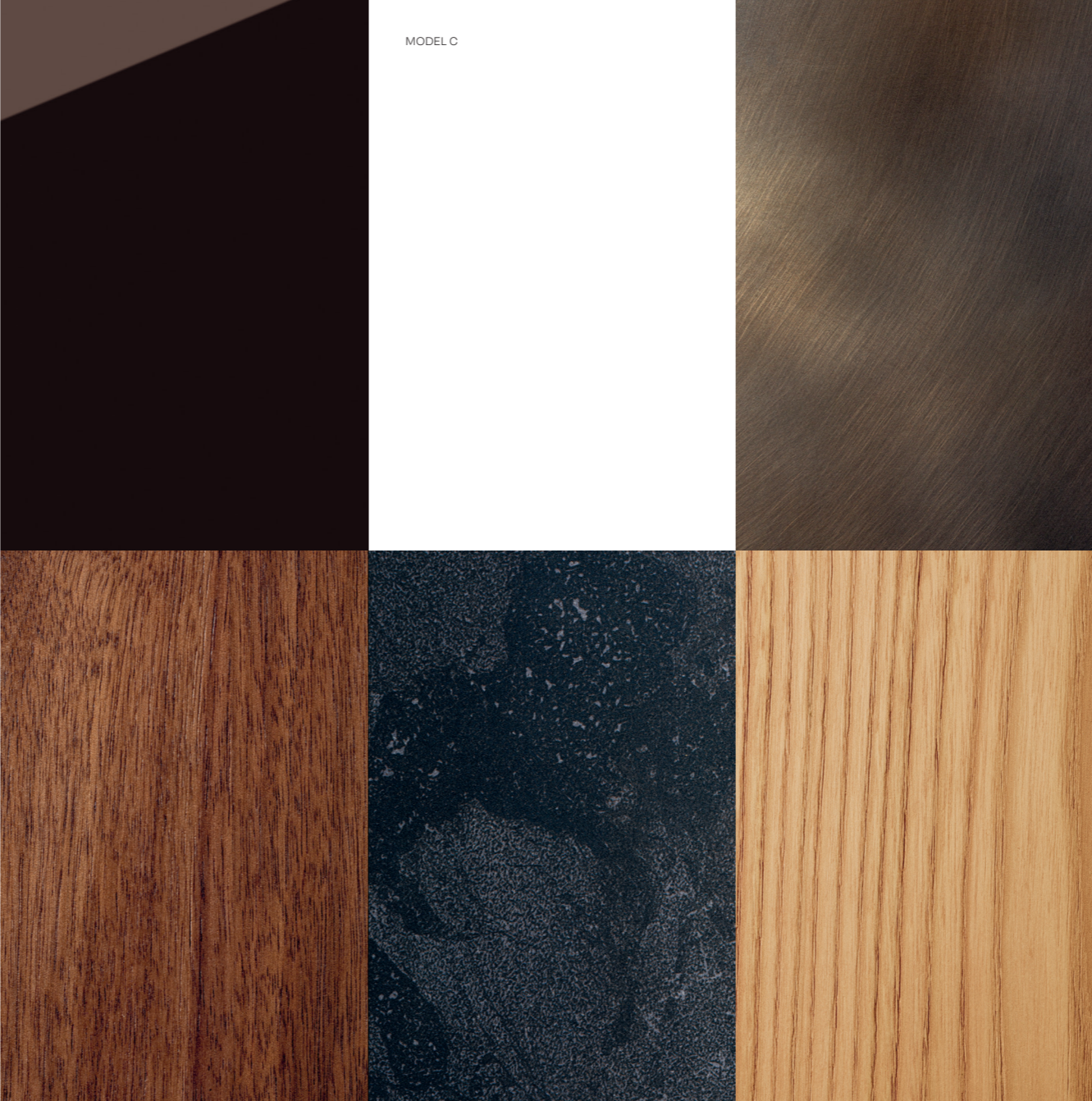

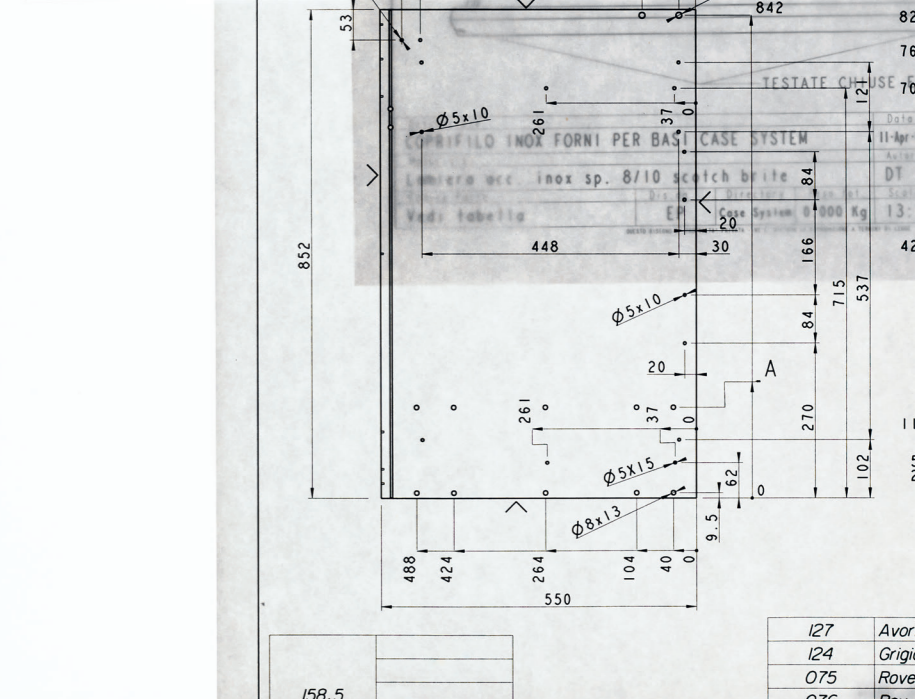
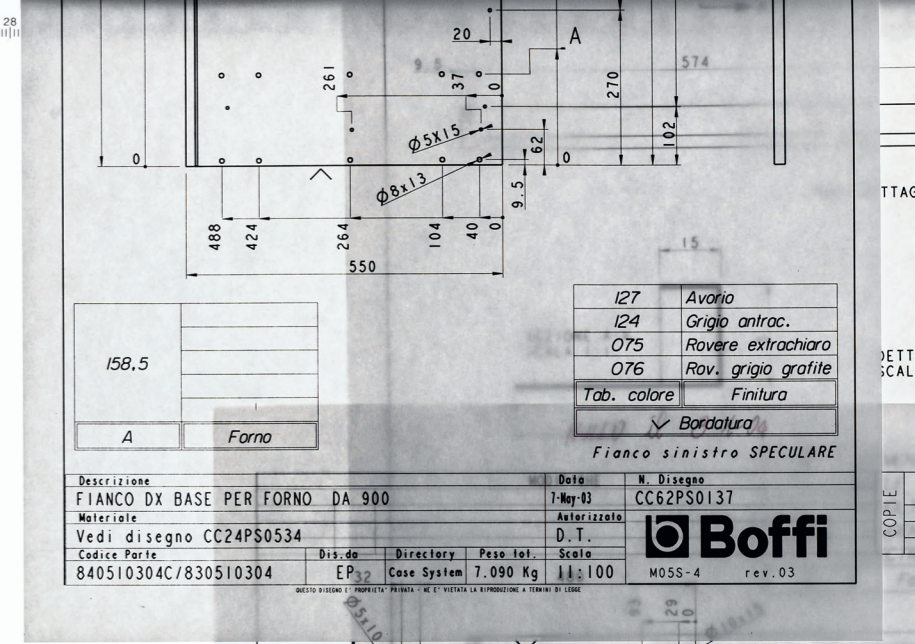



THE ISLAND FEATURES AN ELEGANT GRAY POLYESTER SURFACE, WITH THE LARGE SNACK COUNTER THAT PARTLY RESTS UPON THE COOKING COUNTER, SUPPORTED BY THREE ADJUSTABLE ASYMMETRICAL L-FOOTPRINT BLACK ANODIZED ALUMINUM LEGS. THE 5.0CM THICKNESS OF THE CABINET DOOR — ENCLOSING THE NATURAL WALNUT WOOD DRAWERS — INCORPORATES AN 8MM SECTION THAT FRAMES IT, BECOMING ITS HANDLE. THE HANDLE STRIP WITH THE SAME FINISH AS THE BASE CABINETS REINFORCES THE UNIT'S CONTINUITY. THE CANTILEVERED SNACK COUNTERTOP IS MADE OF EXQUISITE ALPI INDIAN ROSEWOOD, AN ECOWOOD THAT BELONGS TO THE SO-CALLED LOST WOODS FAMILY: WOOD THAT IS DIFFICULT TO OBTAIN BECAUSE IT COMES FROM PROTECTED TREES. ROSEWOOD IS MADE BY ALPI USING A RECOMPOSITING PROCESS THAT RESULTS IN AN IMPECCABLE AESTHETIC USING ONLY CERTIFIED FOREST WOOD BASED ON SUSTAINABLE PRODUCTION TECHNIQUES. THE COOKING SURFACE IS MADE WITH MDI DEVON BY INALCO, EXCLUSIVE TO BOFFI, AND INCORPORATES PITT BURNERS, AVAILABLE IN VARIOUS MODULAR CONFIGURATIONS. EASY METALS IRON LUXURY IS THE FINISH THAT COVERS THE HIDE COLUMNS, A BOLD COLOR TONE IN SHARP CONTRAST WITH THE NEW ANTIBES K SYSTEM IN A WARM SMOKED OAK. NOTABLY INSIDE SYSTEM TRACK, HERE USED IN THE IN-BETWEEN TWO TOPS VERSION, IS THE EQUIPPED TRACK INTEGRATED INTO THE COUNTER-TOPS OFFERING SUCH CRUCIAL ACCESSORIES AS CUTLERY AND UTENSIL TRAYS AND HOLDERS FOR KNIVES, SPICES, CUTTING BOARDS, OIL BOTTLES AND THE HOOD, MADE OF MATTE BLACK-PAINTED STAINLESS STEEL.

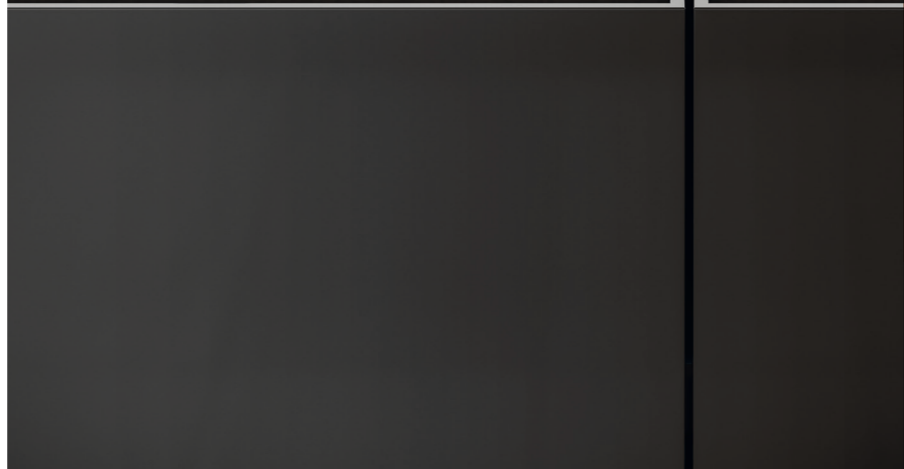
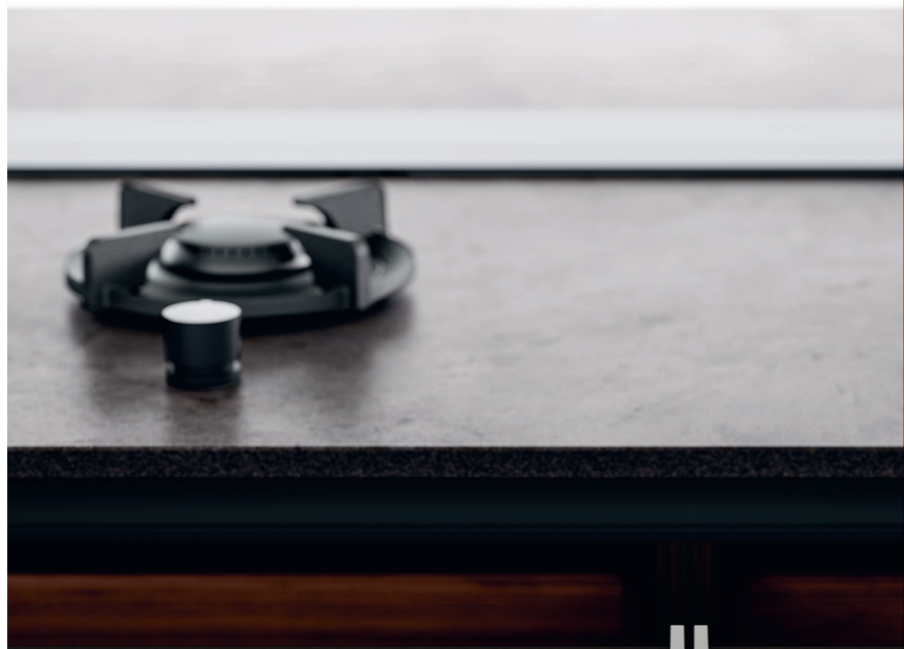



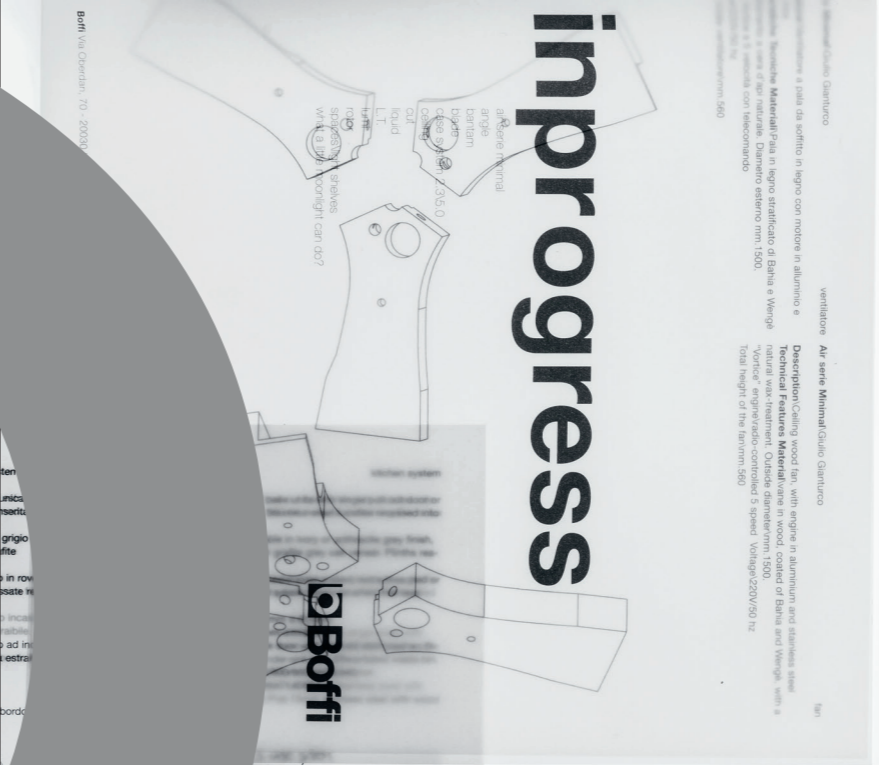

Le venature del marmo corrono senza interruzioni lungo le superfici del blocco cucina - piano, ante, lavandino, zoccolo - creando un disegno continuo perfettamente naturale.

The veins in the marble run uninterrupted along the surfaces of the kitchen block - worktop, doors, sink and plinth - forming a perfectly natural continuous drawing.







THIS KITCHEN DESIGN FEATURES AN ISLAND THAT REFLECTS THE NEW POLYESTER ROPE-COLOR WITH A SURFACE THAT ATTAINS AN UNPARALLELED LEVEL OF BRILLIANCE. THE SNACK COUNTER IN AMERICAN CANALETTO WALNUT VENEER IS AN IMPRESSIVE SQUARE STRUCTURE THAT PARTLY RESTS UPON THE COOKING COUNTER, SUPPORTED BY ADJUSTABLE ASYMMETRICAL L-FOOTPRINT ANODIZED ALUMINUM LEGS. THE COUNTERTOP IN AN MDI BIHARA BY INALCO SURFACE, INTEGRATED WITH AN UNDERCOUNTER INDUCTION COOKING RANGE AND PERFECT SUPPORT OF THE GLASS AND MIRRORED COUNTERTOP CABINETS, GOES IDEALLY WITH THE TILE HOOD. THE COLUMNS FEATURE A NEW EASY METALS LEAD CLASS FINISH.





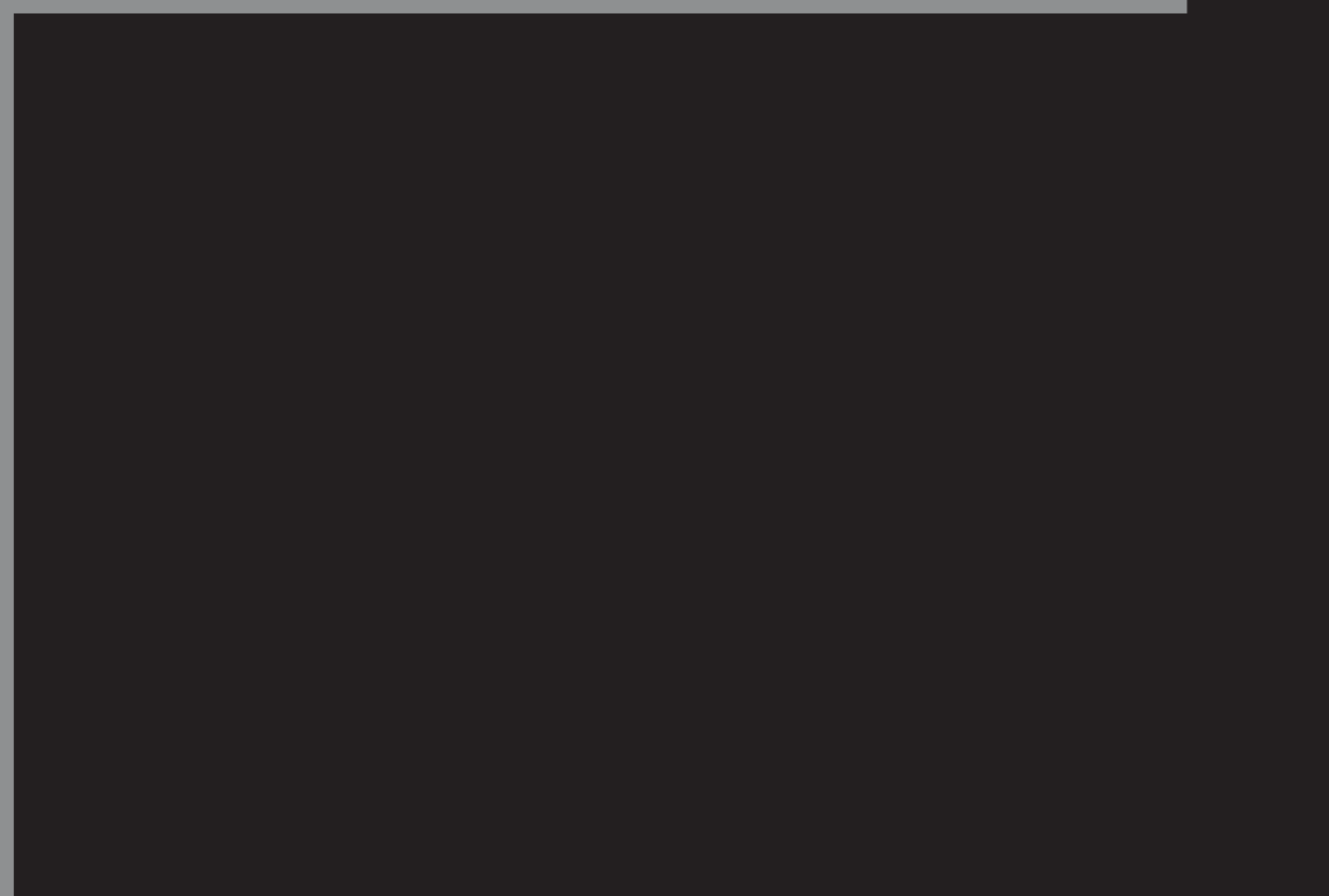





THE ISLAND IS MADE WITH SMOKED OAK VENEER, A MATERIAL THAT ALSO APPEARS IN THE SHELVES OF THE OPEN HOOD. THE BASE CABINETS FEATURE THE 5.0 CM THICKNESS OF THE CABINET DOOR — ENCLOSING THE NATURAL WALNUT WOOD DRAWERS — WHICH INCORPORATES AN 8 MM SECTION. THAT ELEMENT BECOMES THE HANDLE FOR A PULL-OUT OPENING. THE HANDLE STRIP DISPLAYS THE SAME FINISH. THE COUNTERTOP IS IN APPLE BLOSSOM WHITE LASA MARBLE, WHICH SUPPORTS THE MODULAR PITT BURNERS. THE COLUMNS FEATURE A NEW EASY METALS ZINC GLAM FINISH, DEFINING AN INTENSE AND UNUSUAL BLEND OF CONTRASTING BUT PERFECTLY COMPATIBLE HUES. INSIDE SYSTEM TRACK, HERE USED IN THE BUILT-IN VERSION, IS THE EQUIPPED TRACK INTEGRATED INTO THE COUNTERTOPS OFFERING SUCH CRUCIAL ACCESSORIES AS CUTLERY AND UTENSIL TRAYS AND HOLDERS FOR KNIVES, SPICES, CUTTING BOARDS, AND OIL BOTTLES, MADE OF MATTE BLACK-PAINTED STAINLESS STEEL.







ATTENZIONE : Fori per cremagliera da eseguire solo per base dal 200

Attenzione per il forno ELECTRO... distanziali da 608 inserendo fra il... e il distanziale uno spessore di 2 mm...

127	Avorio
124	Grigio, antrac.
075	Rovere extrachiaro
076	Rov. grigio grafite

Descrizione: FIANCO DX BASE PROF. PENSILE 2 CASSETTONI CASE SYSTEM
 Materiale: ...
 Vedi disegno CC24PS0534
 Codice Parte: 840510304C/830510304

Dis. da	Directory	Peso tot.	D. T.
EP	Case System	4.114 Kg	11:100

830230195 608
 830230195 608
 830230195 608
 830230195 608

Forni da 600

Boffi



THE DESIGN OF THE COOKTOP AND THE WALL BASE CABINETS, INCLUDING THE HANDLE STRIP, IS CHARACTERIZED BY THE EASY METALS ZINC GLAM FINISH. BOTH STRUCTURES ARE EQUIPPED WITH DOORS DISTINGUISHING THE ARCHITECTURE OF THE NEW 5.0 DESIGN. THE COUNTERTOP FEATURES SPIDER BLACK QUARTZITE WITH PITT BURNERS, SERVING AS THE SUPPORT FOR THE OVERLAPPING SNACK COUNTER MADE WITH ALPI TEAK, AN ECOWOOD THAT BELONGS TO THE SO-CALLED LOST WOODS FAMILY: WOOD THAT IS DIFFICULT TO OBTAIN BECAUSE IT COMES FROM PROTECTED TREES. TEAK IS MADE BY ALPI USING A RECOMPOSITING PROCESS THAT RESULTS IN AN IMPECCABLE AESTHETIC USING ONLY CERTIFIED FOREST WOOD BASED ON SUSTAINABLE PRODUCTION TECHNIQUES. THAT QUARTZITE ALSO DISTINGUISHES THE SURFACE OF THE WALL BASE CABINETS AND THE BACKING, SUPPORTING THE UPPER CABINETS IN MDI BY INALCO IN THE EXCLUSIVE CROSS TEXTURE, DESIGNED BY PIERO LISSONI. THE GEOMETRY OF THE GLASS HOOD IS IN TRANSPARENT GLASS AND STAINLESS STEEL.

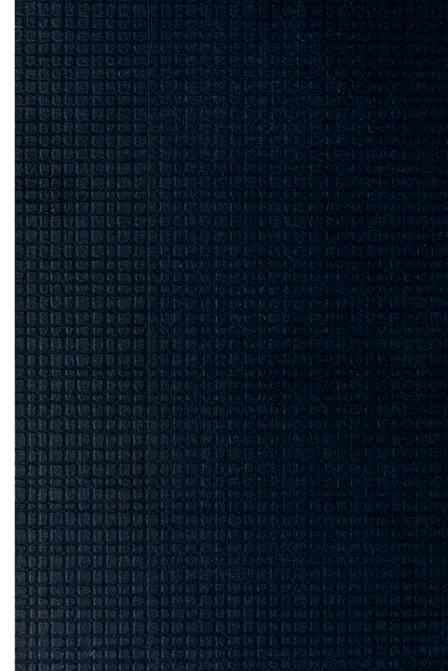
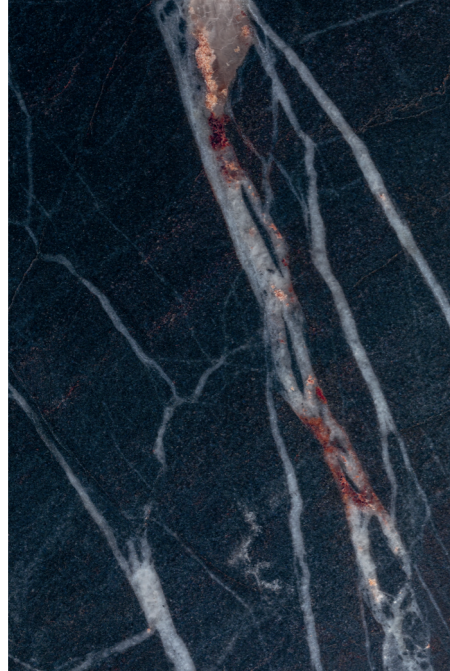









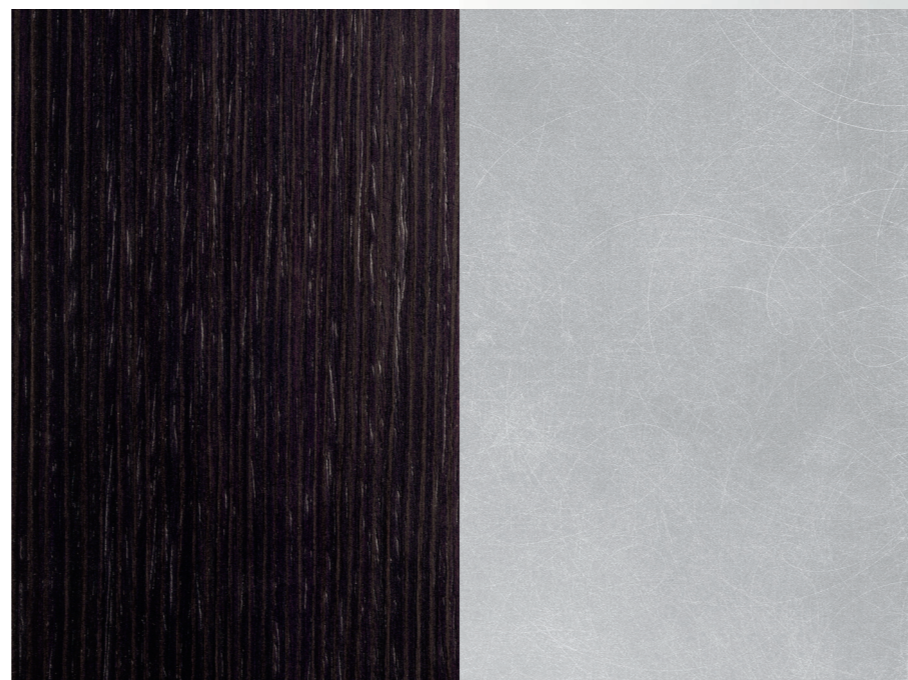



THE ISLAND, THE COUNTERTOP, AND THE PENINSULAR SNACK COUNTER ARE MADE ENTIRELY WITH CORIAN®, SELECTED FOR ITS ESTHETIC AND DESIGN VERSATILITY INASMUCH AS IT IS DURABLE, EASY TO SHAPE, AND OFFERS IMPRESSIVE TECHNICAL PERFORMANCE. THE PITT BURNERS CREATE ADDITIONAL MOVEMENT ON THE COUNTER SURFACE, TOPPING THE BASE CABINETS THAT FEATURE PULL-OUT DRAWERS IN NATURAL WALNUT, AS WELL AS THE STURDY 5 CM CABINET DOOR, INCORPORATING AN 8 MM SECTION THAT OFFERS EASE OF OPENING. ANOTHER NEW FEATURE, THE INSIDE SYSTEM TRACK USED IN THE IN-BETWEEN TWO TOPS VERSION, IS INTEGRATED INTO THE COUNTERTOPS OFFERING SUCH CRUCIAL ACCESSORIES AS CUTLERY AND UTENSIL TRAYS AND HOLDERS FOR KNIVES, SPICES, CUTTING BOARDS, OIL BOTTLES AND THE HOOD, MADE OF MATTE BLACK-PAINTED STAINLESS STEEL. THE HIDE COLUMNS ARE COVERED WITH O_STEEL SILVER, IN CONTRAST WITH NEW ANTIBES K COLUMN SYSTEM IN ECOWOOD XILO 2.0 STRIPED BLACK.

7 8 9

Piero Lissoni

e System 2.3 Sistema con anta a battente

l.

Materiali Corian® di betulla placcato rovio anodizzato effetto n.23 realizzate in Acciaio grafite, poliestere, acciaio inox stampate mm l.450/600/900/1200 spessore 410mm l.900/1200 assettoni o anta unica con pattumiera differenziata battente h.1160 / 600mm l.450/600/900 mm p.340mm l.15 o 65 mm. prof. 677/1244 mm. l. 4000 mm.

Wall unit dimensions h.1160/600mm w.450/600/900mm d.340mm
Tops dimensions h.15/65mm w. 677/1244mm l.4000mm
Finishes/Scotch Brite stainless-steel-white Pral-15mm stainless steel with wood edge.
Hob&sink/C.R.S range

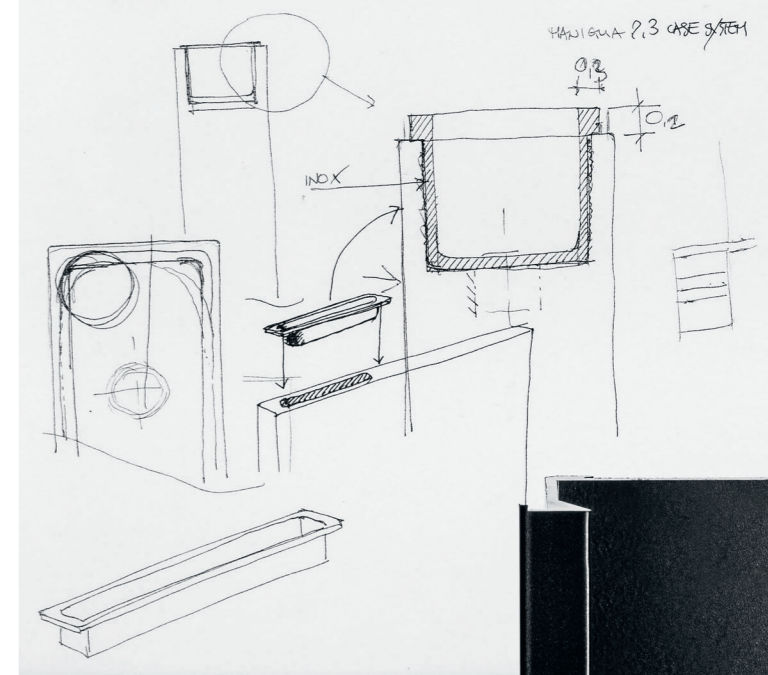

Model 5.0 Piero Lissoni

kitchen system

Case System 5.0 System of pull out base units with handles integrated cabinet structure. System of tall unit modules containing Electrolux appliances fitted by Boffi.

Features Materials/Units available in ivory or anthracite grey finish, birch with extra bleached or grafite grey oak veneer. Plinths realized aluminium grids.

Is available in three finishes/stainless-steel, extra bleached or grafite veneer applied using the 45° folding technique and white Pral applied same folding technique.

h.900mm w.450/600/900/1200mm d.610mm
Base units/Base units with either two drawers or a single door, with or without recessed oven, under-sink base unit with differentiated waste- version or double drawers.

Plinths h.15/65mm w.705/1250/1300mm l.4000mm
Hob&sink stainless-steel, white Pral-15mm stainless steel with

C.R.S range

INDEX

C

PP. 6-17

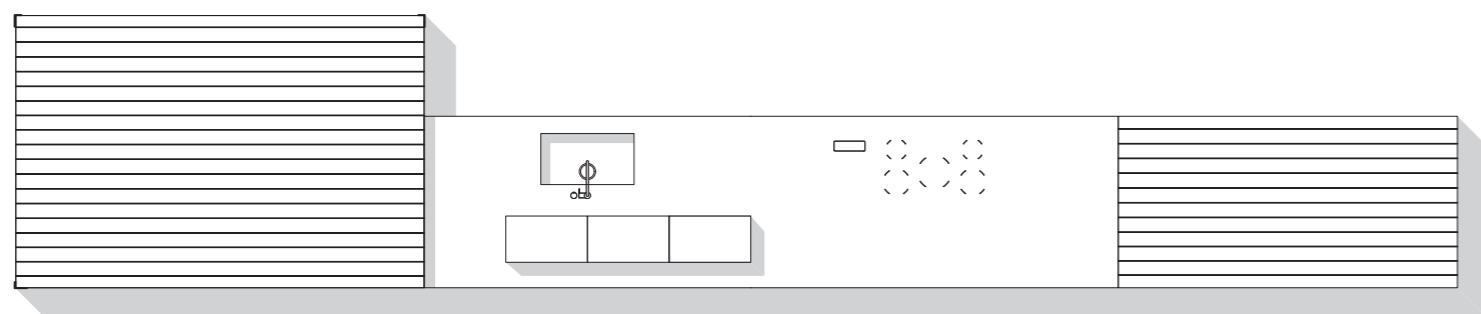

E

PP. 36-43

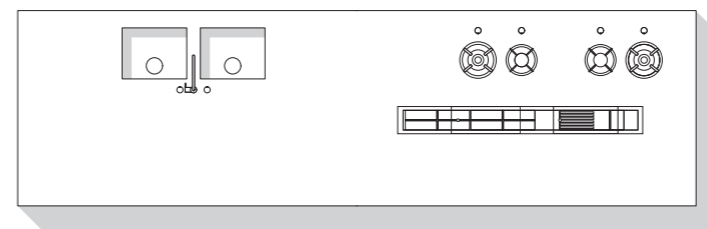

A

PP. 18-25

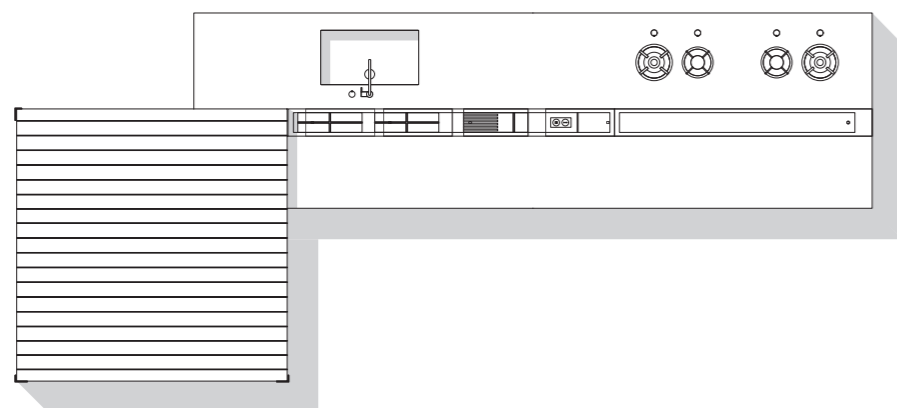

5

PP. 44-51

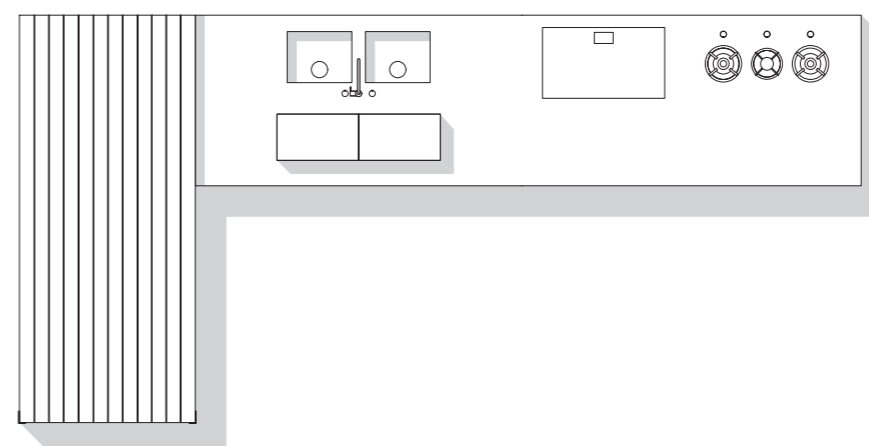

S

PP. 26-35

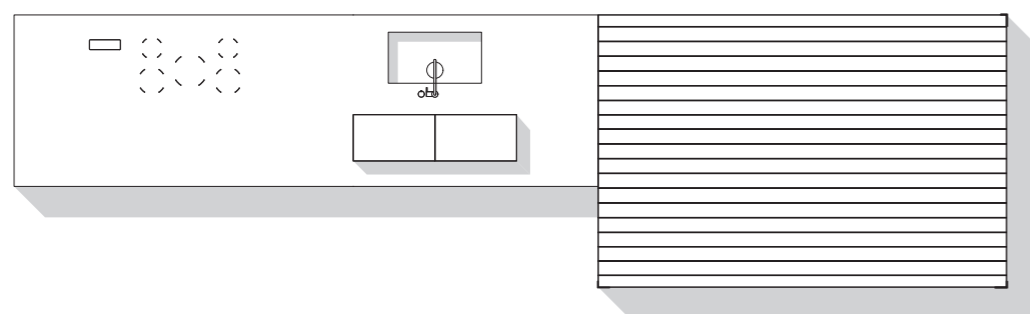

.0

PP. 52-62

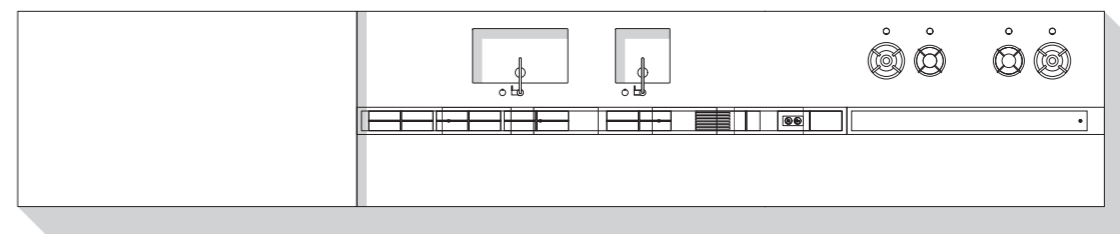

BOFFI SPA VIA OBERDAN, 70
20823 LENTATE SUL SEVESO [MB] ITALY
T. +39 0362 5341
INFO@BOFFI.COM
WWW.BOFFI.COM

CONCEPT AND GRAPHIC DESIGN:
LISSONI GRAPHX
PHOTOGRAPHS: MATTIA PARODI
ARCHIVE PHOTOGRAPHS:
TOMMASO SARTORI, GIOVANNI GASTEL,
DUILIO BITETTO, GIANLUCA VASSALLO
WORDS: ANTONY SHUGAAR
DIGITAL RENDERING: NUDESIGN
RETOUCHING / PRE - PRESS: DE PEDRINI
PRINTING: NAVA PRESS 2022

SOME PRODUCTS SHOWN IN THIS CATALOGUE MAY NOT BE IN THE BOFFI
PRODUCT LISTING. MODIFICATIONS AND IMPROVEMENTS TO PRODUCTS
COULD VARY FROM THE SOLUTIONS PRESENTED.

EACH BOFFI PRODUCT IS MADE IN ITALY IN ACCORDANCE WITH
ISO 9001:2015 REGULATIONS. THE ISO 14001:2015 STANDARDS ENSURE
THE ENVIRONMENTAL IMPACT AT EVERY STAGE OF PRODUCTION.
THE QUALITY AND ENVIRONMENTAL POLICIES PROVIDE CONTINUOUS
IMPROVEMENT ACTIONS THAT INVOLVE THE ENTIRE ORGANIZATION.
BOFFI PRODUCTS ARE GUARANTEED FOR 3 YEARS, AS OF THE DATE OF THE
GUARANTEE CERTIFICATE ISSUE.

BECOMING: HERE IS
THE SOUL OF A NEW
KITCHEN. RISING
FROM TRANSLUCENT
STRATA OF CREATIVE
WORKSHEETS
— ROUGH SKETCH,
FINE RENDERING,
FACTORY SCHEMATIC,
MATERIALS SAMPLE
BOARD. AT THE APEX,
THE BUILT KITCHEN:
SPARE, CLEAN,
ELEGANT. CASE 5.0.